

Sagitta系列

Sagitta产品特点

- 高质量合金材料.
- 高度可从80mm调整到400mm, 节省空间.
- 合金材质与银色支架将使你的显示屏及工作环境更具现代感.
- 坚固的支架即使载重也能移动顺畅.
- 组合式的配件可依需求选择搭配.
- 内含理线装置, 可将线材隐藏在支架下方.
- 符合VESA标装安装孔位:75×75mm/100mm×100mm

锁孔式显示屏支架



LA-52-3

(LA-502+LA-511+LA-514)

零件规格图

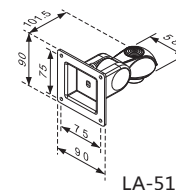
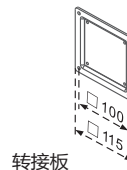
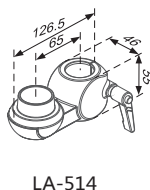
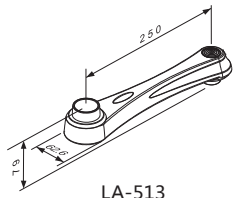
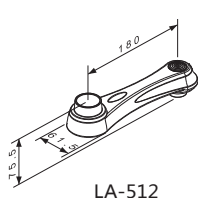
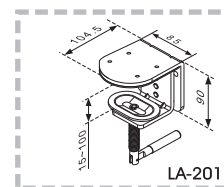
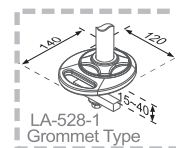
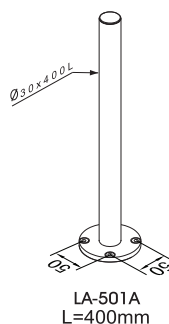
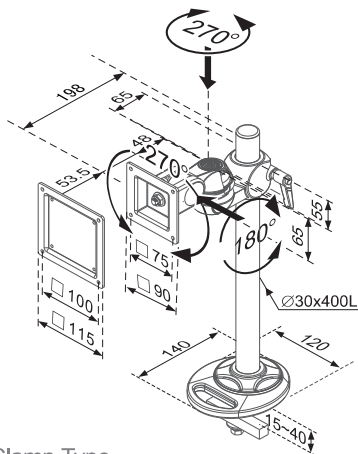

产品配件说明表

材质	料号	零组件	LA-502	LA-511	LA-512	LA-513	LA-514	载重量 (KG)
	型号		a 无缝钢管/银色 b 铝合金/银色	a 无缝钢管/银色 b ABS塑胶/银色 c 冷轧板/银色	铝合金材质/银色	铝合金材质/银色	铝合金材质/银色	
	LA-52-3		1	1			1	12KGS



公司官网



公众号



产品参数